

FASAD MOT VÄST (GÅRD)

SKALA 1:50
METER
0 1 2 5

A	TF OVAN TRAPPHUS TILLAGT	2021-08-20	JE
BET	ANDRINGEN AVSEER	DATUM	SIGN
BYGGLOVSHANDLING			
SKIFTESGATAN 4			
BRÅMAREGÅRDEN 45:11			
<input checked="" type="checkbox"/>	A FastBolaget	tel. 0735-676849	
UPPDRAG NR	RITAD/KONSTR. AV	HANDLÄGGARE	
4511	JE	JE	
DATUM	ANSVÄRIG		
2021-05-31	JOEL ESKILSSON		
INREDNING AV VIND TILL BOSTAD			
FASAD GÅRD			
SKALA	NUMMER	BET	
A1 1:50	A-40.3-10	A	
A3 1:100			

FÖRKLARINGAR

- G GARDEROB
- K/F KYL OCH FRYS
- DM DISKMASKIN
- TF1 TAKFÖNSTER 1140x1600
- TF2 TAKFÖNSTER 1140x1400
- BEF. AVLOPPSLUFTARE

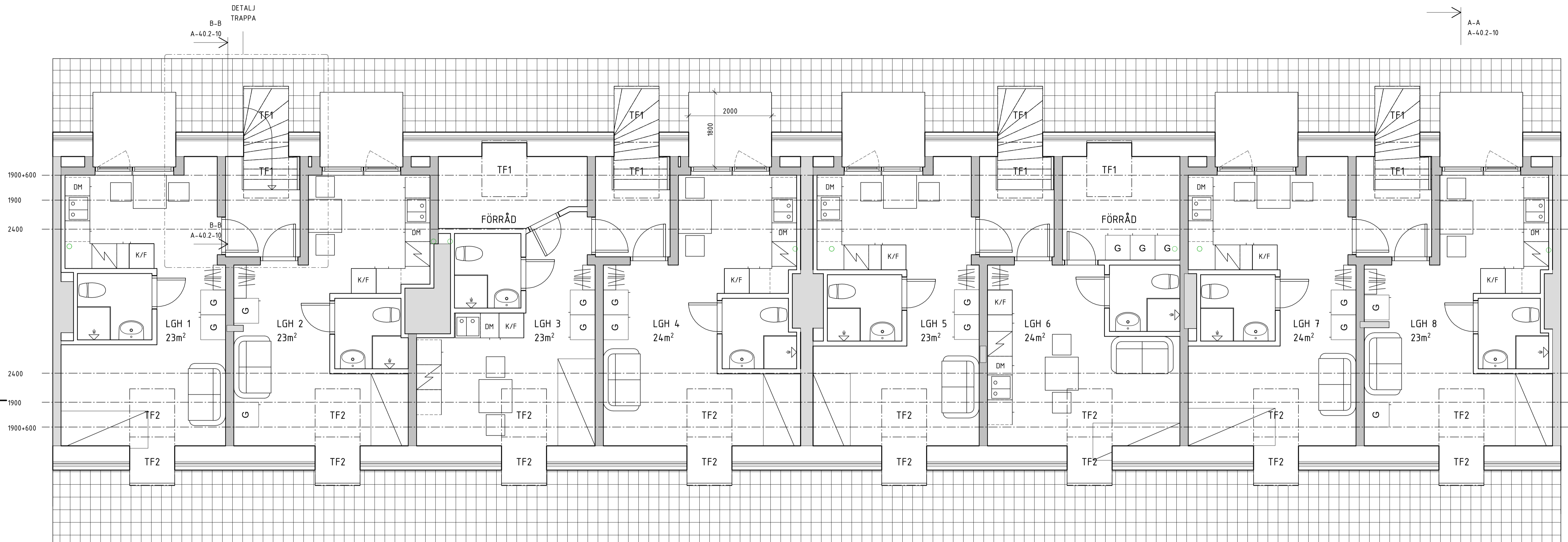

VIND

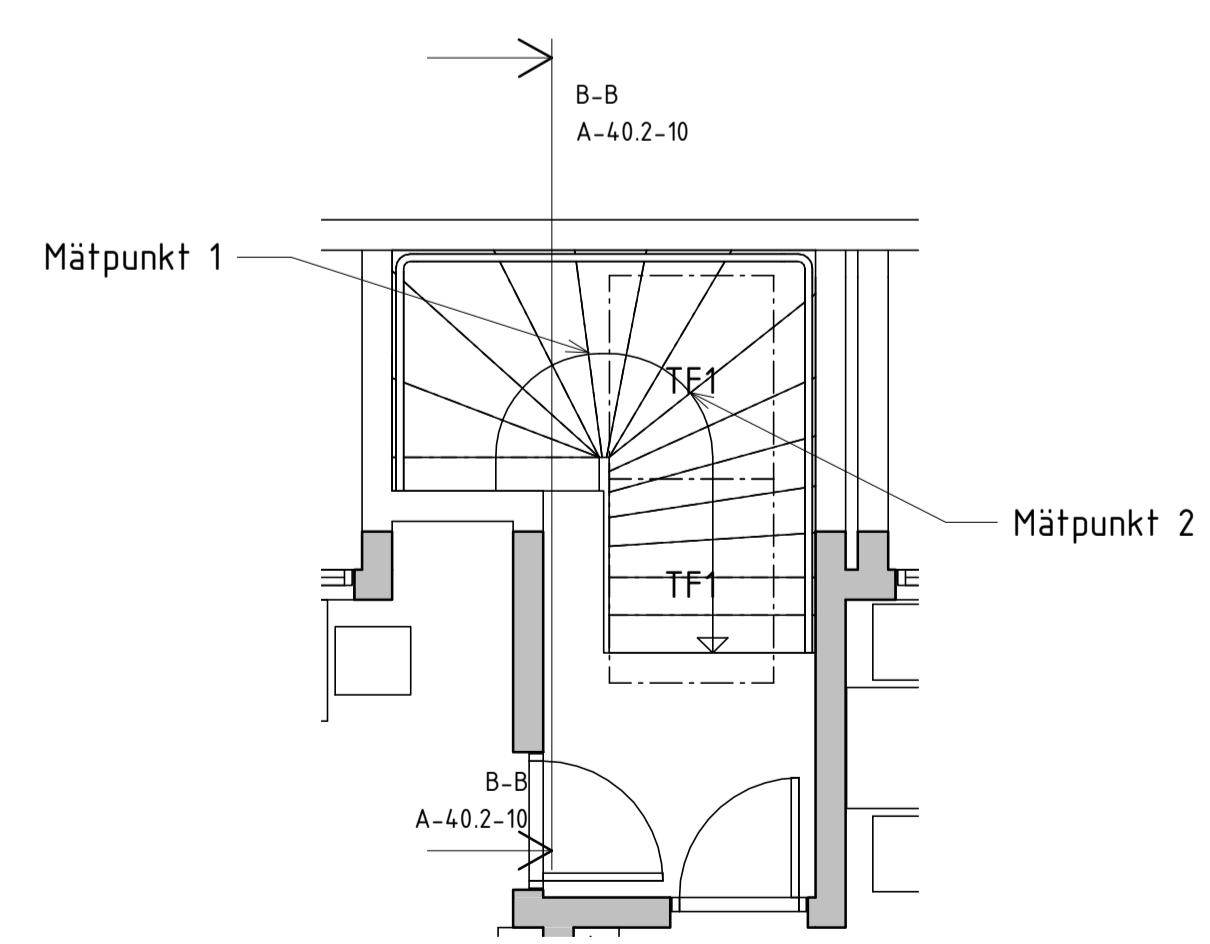

DETALJ TRAPPA

B	TF OVAN TRAPPHUS TILLAGT	2021-08-20	JE
A	DETALJ TRAPPA TILLAGD	2021-07-15	JE
BET	ANDRINGEN AVSER	DATUM	SIGN

BYGGLOVSHANDLING	
SKIFTESGATAN 4	
BRÄMAREGÅRDEN 45:11	
<input checked="" type="checkbox"/> A FastBolaget	tel. 0735-676849
UPPDRAG NR 4511	RITAD/KONSTR. AV JE
DATUM 2021-05-31	HANDLÄGGARE JE
INREDNING AV VIND TILL BOSTAD PLAN	
SKALA A1 1:50 A3 1:100	NUMMER A-40.1-10

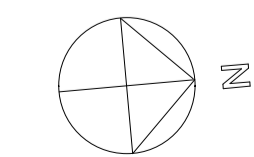
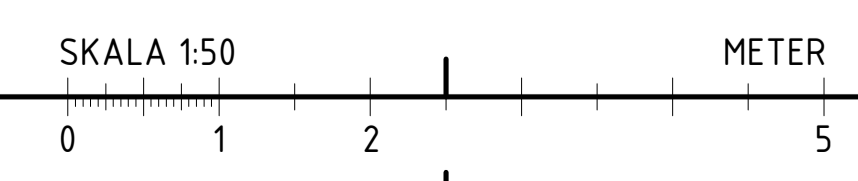

A-A
A-40.2-10

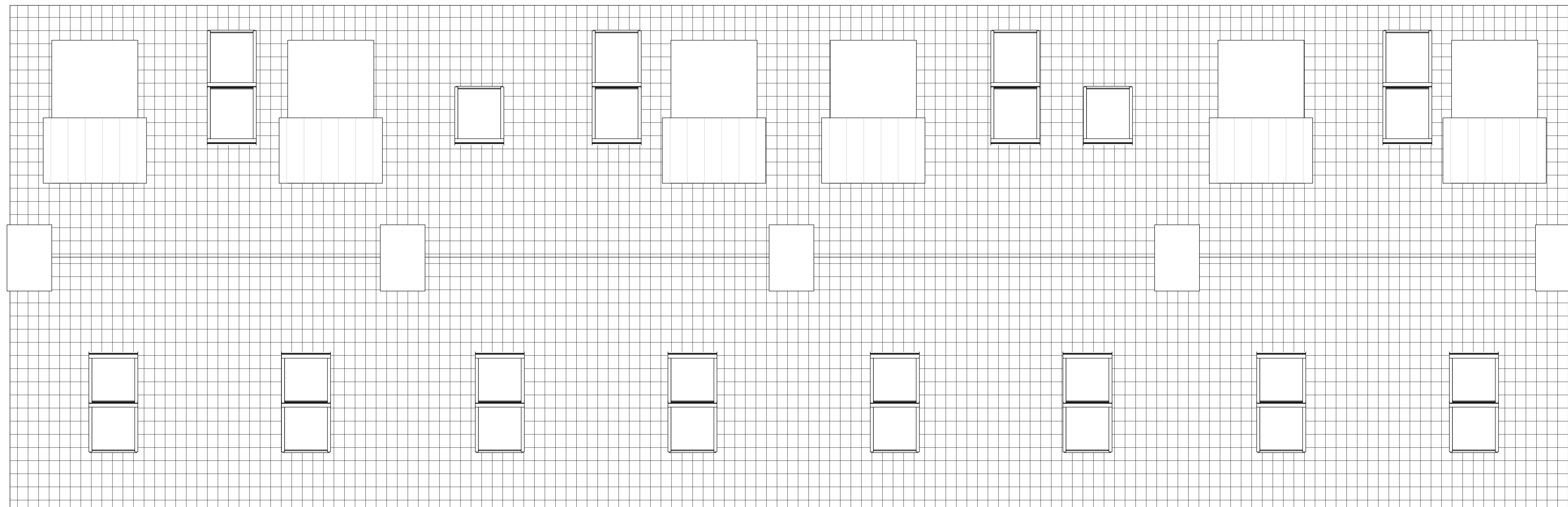

TAKPLAN

A-A
A-40.2-10

A	TF OVAN TRAPPHUS TILLAGT	2021-08-20	JE
BET	ANDRINGEN AVSER	DATUM	SIGN
BYGGLOVSHANDLING			
SKIFTESGATAN 4			
BRÅMAREGÅRDEN 45:11			
<input checked="" type="checkbox"/>	A FastBolaget	tel. 0735-676849	
UPPDRAG NR	RITAD/KONSTR. AV	HANDLÄGGARE	
4511	JE	JE	
DATUM	ANSVÄRIG		
2021-05-31	JOEL ESKILSSON		
INREDNING AV VIND TILL BOSTAD			
TAKPLAN			
SKALA	NUMMER	BET	
A1 1:50	A-40.1-20	A	
A3 1:100			

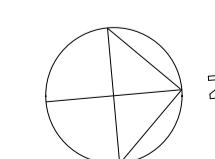

SKALA 1:50
METER
0 1 2 5

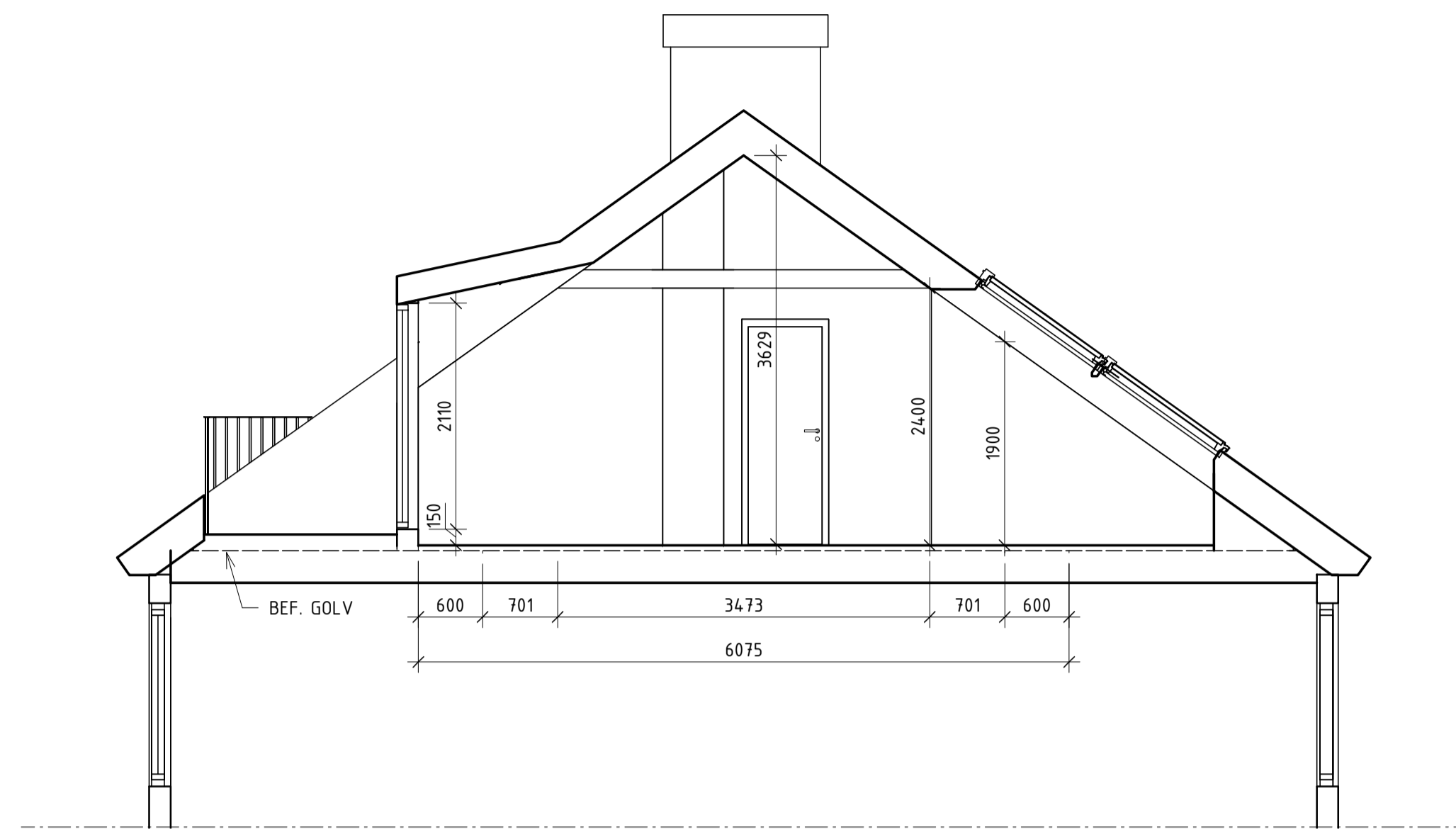

A-A

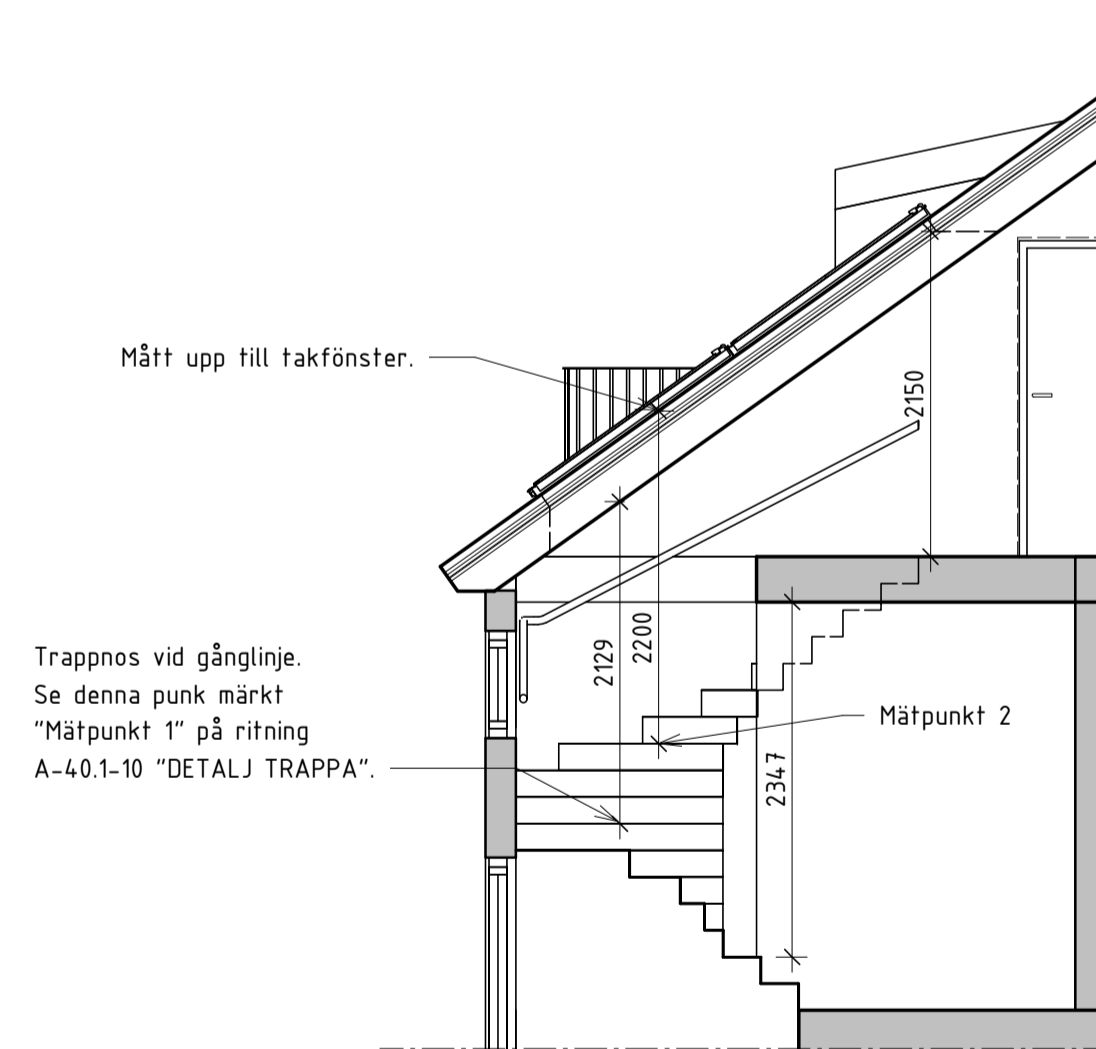

B-B

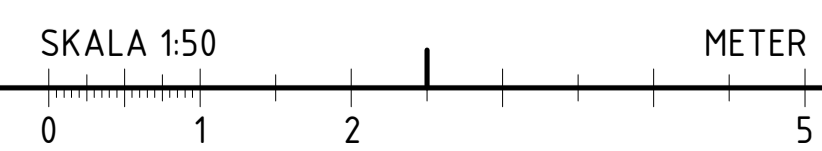

B	TF OVAN TRAPPHUS TILLAGT	2021-08-20	JE
A	SEKTION B-B TILLAGD	2021-07-15	JE
BET	ANDRINGEN AVSER	DATUM	SIGN
BYGGLOVSHANDLING			
SKIFTESGATAN 4			
BRÅMAREGÅRDEN 45:11			
<input checked="" type="checkbox"/>	A FastBolaget	tel. 0735-676849	
UPPDRAG NR	RITAD/KONSTR. AV	HANDLÄGGARE	
4511	JE	JE	
DATUM	ANSVÄRIG		
2021-05-31	JOEL ESKILSSON		
INREDNING AV VIND TILL BOSTAD			
SEKTIONER			
SKALA	NUMMER	BET	
A1 1:50	A-40.2-10	B	
A3 1:100			